

PATENT SPECIFICATION

1,034,117



1,034,117

Inventor: ALEXANDER JOHN CHERNEY.

Date of Application and filing Complete Specification: May 28, 1963.

No. 21246/63

Complete Specification Published: June 29, 1966.

© Crown Copyright 1966.

Index at Acceptance:—E1 B (1A2B, 1A3B, 1B3, 1E1A, 1E2C, 1F1B, 1F2X, 1G2B, 1G2C, 1G2D).

Int. Cl.:—E 04 c 1/12.

COMPLETE SPECIFICATION

DRAWINGS ATTACHED

Improvements in or relating to Building Elements

We, ALLOC LIMITED, of 53, Shakespeare Road, Mill Hill, London, N.W.7., a Body Corporate organised under the laws of Great Britain, do hereby declare the invention, for which we pray that a patent may be granted to us, and the method by which it is to be performed, to be particularly described in and by the following statement:

This invention relates to building elements, and more particularly to prefabricated slabs for forming walls, floors, partitions and the like.

At the present time there are on the market a variety of prefabricated building elements, mainly made from concrete. However, most of the known elements are complicated in form and difficult to erect, and furthermore require a costly form of production. In consequence, the majority of such elements are expensive and therefore not economical in comparison with normal building materials and methods.

The object of the present invention is to provide a novel form of building element which is relatively cheap to manufacture and very easy to erect, and provided with interengaging formations to connect one element with an adjacent or opposed element of similar shape.

Accordingly the present invention provides a building element comprising a substantially rectangular wall member having a plane outer surface and a transverse web projecting from the inner surface of said wall member and extending substantially over the whole of one dimension thereof, the wall member and the transverse web together constituting an L-sectioned body, the web being provided with a plurality of grooves to engage it to the similar web of another opposed such element, the grooves of the web including plane bearing surfaces which are parallel to the plane surface of

the wall member, whereby the interengagement of said webs by means of their grooves prevents relative movement of the two elements in the direction normal to their plane surfaces.

Advantageously the web of the building element has grooves provided on both its inner and its outer face, whereby the web of one such element may engage by means of the grooves provided on its inner face with the grooves provided on the outer face of an adjacent element.

The wall member may also be provided with grooves on its inner face, and such grooves preferably extend in a direction normal to the longitudinal axis of the web. The grooves provided on the wall member are preferably in the form of a plurality of spaced parallel channels, and such channels are advantageously of square cross-sectional shape.

Accordingly to another aspect of the invention the web is provided with grooves on its inner surface only, the outer surface of the web being concavely curved and the inner surface of the wall also being concavely curved.

Preferably said concave surfaces are of such curvature that, when four such building elements are coupled together, the cavity formed between such four building elements is substantially elliptical.

Two embodiments of the present invention are hereinafter particularly described, by way of example, with reference to the accompanying drawings, wherein:—

Fig. 1 is a perspective view of a first embodiment of building element;

Fig. 2 is a top plan view of a cavity wall formed by a pair of opposed building elements as shown in Fig. 1;

Fig. 3 is a vertical section through a wall formed by a pair of opposed building ele-

[Price 4s. 6d.]

ments and including an infill element;

Fig. 4 is a perspective view of the infill element shown in section in Fig. 3;

Fig. 5 is a horizontal section through a wall, showing two methods of keying opposed building elements;

Fig. 6 is a front elevation of a section of wall formed from substantially square building elements;

Fig. 7 is a front elevation of a section of wall formed from elongated rectangular elements;

Fig. 8 is a plan view of a second embodiment of building element;

Fig. 9 is a plan view of a pair of building elements as shown in Fig. 8 and interconnected by means of their respective webs; and

Fig. 10 is a plan view of a section of wall formed by use of the building elements shown in Fig. 8.

In the first embodiment of building element illustrated more specifically in Figs. 1 to 5, the building element comprises a rectilinear wall member 1 and a transverse web 2 projecting from the inner face of the wall member 1 and extending over the whole length thereof, the web 2 being provided with grooves 3 arranged to key the web to a filling, as hereinafter explained, or to the similar web 2 of another opposed such element, such as to prevent movement normal to the plane of the wall member, as shown in Figs. 2 and 5. As shown in Fig. 1, the wall member 1 is also provided with channels 4 along those edges extending parallel to the plane of the web 2, these channels 4 being arranged to receive a fillet 5 as shown in Figs. 2 and 5 to conjoin two adjacent wall members 1. Advantageously, the channels 4 are provided on all four edges of the wall member 1 in order that such member can be conjoined both laterally and transversely with other such members by the fillets 5.

The inner face of the wall member 1, i.e. that face from which the web 2 projects, is, in this embodiment, provided with a plurality of spaced parallel channels 6 extending from that edge of the wall member 1 remote from the web 2 up to the web 2. These channels 6 are provided to key with an infill of concrete or other material or with an infill element 7 as illustrated in Figs. 3 and 4.

In use, the building element shown in Fig. 1 can be employed to form various forms of wall. By coupling the elements in the manner indicated in Fig. 2, a "cavity wall" can be formed by arranging the elements in opposed rows with their respective webs 2 interengaged, thus provided a cavity 8. However, as indicated at the left-hand side of Fig. 2, this cavity may be filled with a heat or sound insulating

material, such as fibre-glass or other known insulating material, indicated at 9.

In other applications, particularly in walls where additional compressive strength is required, the infill element 7 of Fig. 4 can be introduced into the cavity as illustrated more specifically in Fig. 3. The spaced parallel channels 10 of the infill element 7 may be arranged, as shown in the upper portion of Fig. 3, to interengage with the channels 6 of one of the wall members 1, or they may be arranged as shown in the lower portion of Fig. 3 in alignment with the channels 6 to receive bonding members 11 therebetween. As shown in Fig. 3, between the plane surface of the infill element 7 and the other opposed wall member 1 there may be provided a sheet of insulating or other material, such as a bonding material, indicated at 12, or the space between such infill element 7 and such opposed wall member 1 may be filled with concrete or the like.

If, for the purpose of supporting heavy structures or for any other reason, additional strength is required in the vertical direction of the wall, then reinforced or pre-stressed pillars 13 can be cast *in situ* between two spaced webs 2 as illustrated at the right-hand side of Fig. 5, the channels 3 in the webs 2 then being effective to bond the building elements to such pillar.

It will be appreciated that such building elements may be of substantially square shape such that they can be arranged in the manner indicated in Fig. 6 to form a wall or a floor, or that they may be of elongated rectangular shape as indicated in Fig. 7 to provide walls with window or other openings as shown at 14.

Figs. 8, 9 and 10 illustrate a second embodiment of building element, more suitable for constructing floors and ceilings, and comprising a wall member 20 having a web 21 projecting from one face of the wall member 20 and extending over the whole length thereof, the web 21 having grooving 22 arranged to key the web to the similar web 21 of another opposed such element.

In this second embodiment, however, the wall member 20 is provided with an outer plane surface 23 and an inner concave surface 24, and the web 21 is provided only on its inwardly directed face with grooving 22, whilst its outer face 25 is also concave and of such curvature that, together with the curvature of the concave face 24 of the wall member 20, a cavity of substantially elliptical shape is formed between four interconnected building elements, as shown in Fig. 10.

This particular shaping of the building elements, to provide a substantially elliptical cavity between the four elements, is of

importance, inasmuch as the coupled webs 21 are of a shape more readily able to resist bending stresses set up by heavy weights placed thereon, when such elements are used as a floor.

5 Furthermore, in this second embodiment, the wall member 20 is provided along one edge, adjacent and parallel to the web 21, with a groove or channel 26 and along the 10 opposite edge thereto with a complementary tongue 27 arranged to seat in the channel 26 provided in the next adjacent building element, as indicated in Figs. 9 and 10.

15 In use, the channels 22 of the webs 21 would be provided with an adhesive coating as would the channel 26 and tongue 27 so that when the various building elements have been positioned as required no further casting of concrete or the like thereon is 20 required.

When these building elements are used as a ceiling of one room and simultaneously form the floor of the room thereabove, the building elements forming the bottom row 25 (i.e. those forming directly the ceiling) could be prestressed or be provided with reinforcement rods, as at 28 (Fig. 10), in order that they may better withstand the tensional bending stresses to which they 30 would be subjected.

The elliptical cavities formed between the building elements when the latter are interconnected could be utilised for the installation of all normal services, e.g. water 35 pipes, electrical wiring and the like. Additionally, these building elements could be manufactured in the required lengths to completely span a room, so that they could be laid side-by-side across the floor or ceiling. 40 If necessary, they could also be manufactured in shorter lengths and be provided with interlocking end formations (not shown) so that the required span could be built up as required.

45 The building elements above described, both of the first and second embodiments, may be manufactured by casting or moulding from concrete, certain waste products, such as wood chippings and the like together with a suitable bonding agent, or 50 from any other material suitable for the purpose.

Such elements would be cheap to manufacture and relatively easy to handle and 55 erect, thus reducing considerably the time and labour factor in the erection of a

building.

WHAT WE CLAIM IS:—

60 1. A building element comprising a substantially rectangular wall member having a plane outer surface and a transverse web projecting from the inner surface of 65 said wall member and extending substantially over the whole of one dimension thereof, the wall member and the transverse web together constituting an L-sectioned body, the web being provided with a plurality of grooves to engage it to the similar 70 web of another opposed such element, the grooves of the web including plane bearing surfaces which are parallel to the plane surface of the wall member, whereby the inter- 75 engagement of said webs by means of their grooves prevents relative movement of the two elements in the direction normal to their plane surfaces.

2. A building element as claimed in claim 1 wherein the web of the building 80 element has grooves provided on both its inner and its outer face, whereby the web of the one such such element may engage by means of the grooves provided on its 85 inner face with the grooves provided on the outer face of an adjacent element.

3. A building element as claimed in claims 1 or 2, wherein the inner surface of the wall member is provided with grooves 90 running normal to the longitudinal axis of the web.

4. A building element as claimed in claim 1 wherein the web is provided with grooves on its inner surface only, the outer 95 surface of the web being concavely curved and the inner surface of the wall also being concavely curved.

5. A building element as claimed in claim 4 wherein, said concave surfaces are of such curvature that, when four such build- 100 ing elements are coupled together, the cavity formed between such four building elements is substantially elliptical.

6. A building element constructed and arranged substantially as hereinbefore par- 105 ticularly described with reference to either of the embodiments illustrated in the accompanying drawings.

For the Applicant:
CHATWIN & COMPANY:
Chartered Patent Agents,
253, Gray's Inn Road,
London, W.C.1.

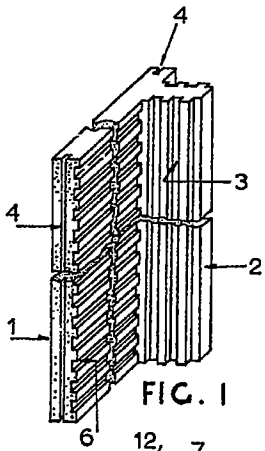

FIG. 1

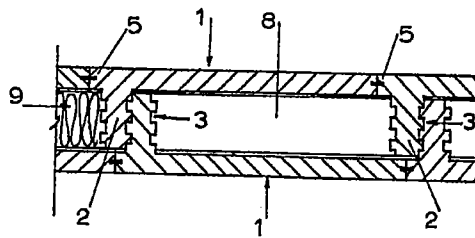

FIG. 2

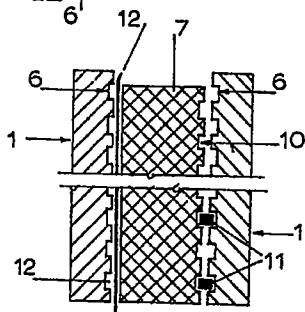

FIG. 3

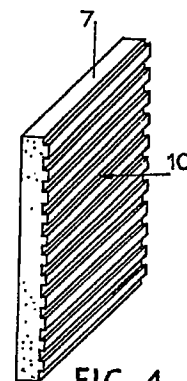

FIG. 4

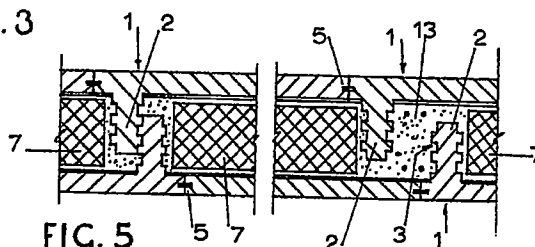

FIG. 5

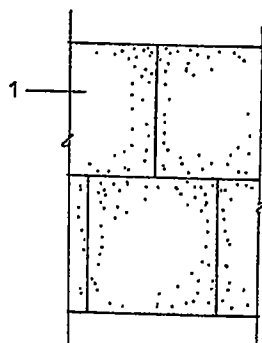

FIG. 6

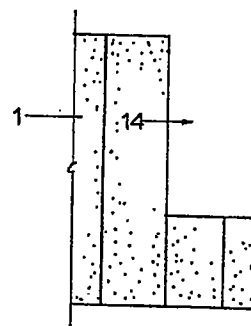

FIG. 7

1,034,117 COMPLETE SPECIFICATION

2 SHEETS

This drawing is a reproduction of
the Original on a reduced scale.
SHEETS 1 & 2

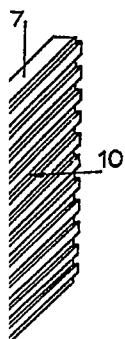
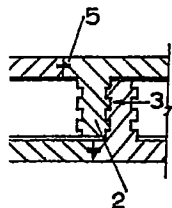

FIG. 4

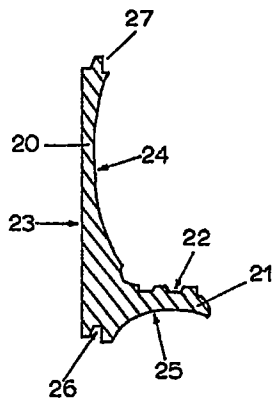
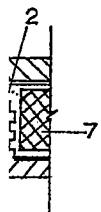

FIG. 8

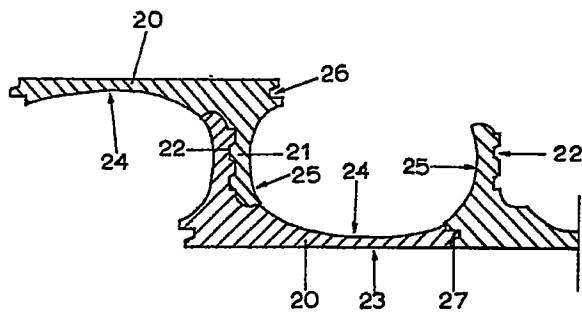

FIG. 9

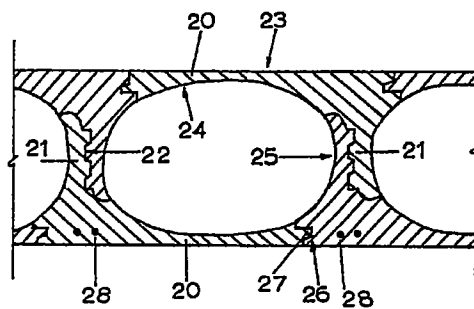

FIG. 10

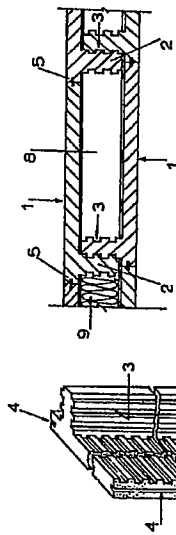

FIG. 1

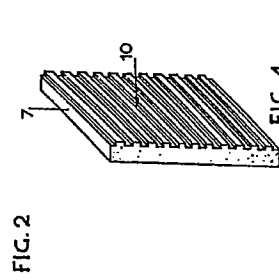

FIG. 2

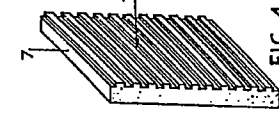

FIG. 3

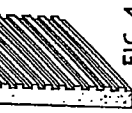

FIG. 4

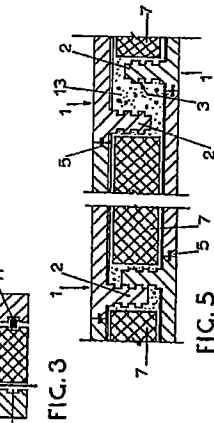

FIG. 5

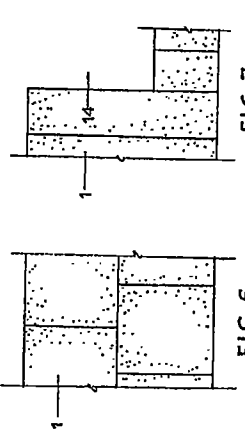

FIG. 6

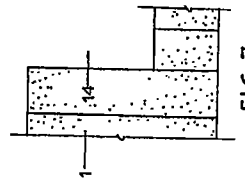

FIG. 7

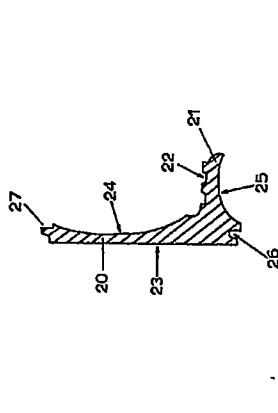

FIG. 8

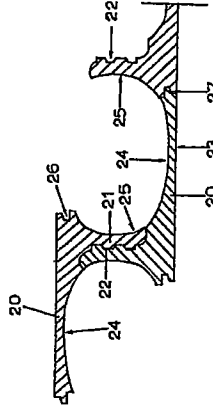

FIG. 9

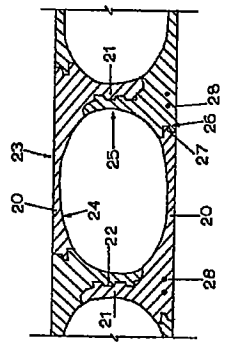

FIG. 10